



HIGH PERFORMANCE  
**CRANE ROPE**



## OUR WORLD

Usha Martin is one of the largest manufacturers of wire ropes in the world. Our journey of more than six decades has been focused on manufacturing excellence, product innovation, technology upgradation and customer satisfaction which resulted in establishing Usha Martin crane ropes as one of the preferred and trusted brands in the world.

Our manufacturing architecture includes latest generation of machineries starting from automatic pickling plant, state-of-the-art patenting furnaces and high speed straight - through wire drawing machines for producing high quality highest tensile wires that are required for manufacturing high performance crane ropes. Our quality management system has been certified as per ISO 9001:2015 standards, along with manufacturing assessment certifications from ABS, Lloyd's, DNV, SNI, CCS, Class NK, and BV Marine & Offshore. We also hold certificate of authority for the API monogram.

Our crane ropes are extensively used in high-capacity cranes installed in renowned ports of the world and by world-class crane manufacturing companies in non-critical and critical applications. Our crane ropes are developed to perform smoothly in extreme temperatures as well as in challenging environmental conditions.

Our desire to excel is manifested through our group dynamics having manufacturing facilities in India, Thailand, Dubai & United Kingdom, distribution centres spread over all continents, Global Development Centre in Italy and service centres in India, Netherlands, Scotland, Singapore, Dubai and Saudi Arabia. Our service module through the Customer Value Management (CVM) initiative has elevated us from a wire rope supplier to a lifting solution provider and enabled us to partner the growth process.

## GLOBAL FOOTPRINT

 **60+** YEARS OF LEADERSHIP

 PRESENCE ACROSS **75+** COUNTRIES

 **07** MANUFACTURING FACILITIES

 **02** R&D CENTRES

 **250+** GROUP DISTRIBUTION CENTRES AND CHANNEL PARTNERS



## MANUFACTURING CAPABILITIES

- Our state-of-the-art manufacturing facilities have the capability to produce wire ropes ranging upto 160 mm in diameter and are available in various tensile grades, from 1370 to 2160 N/mm<sup>2</sup> tensile.
- Our fully equipped rigging shop allows pressed terminations from 3 mm to 128 mm and wire rope socketing up to 165 mm.
- Undergoing all kinds of destructive and non-destructive testing.
- 9000 kN rope breaking load testing machine.
- All crane ropes undergo rigorous testing procedures to meet the technical specifications as per our customer demand for today's challenging working conditions.
- Our technical experts offers on-site installation services and conduct periodic wire rope inspections for customers.

# EMPOWERING CUSTOMER SUCCESS THROUGH CUTTING-EDGE SOLUTIONS



Delivering one-stop crane rope solutions tailored to your unique needs.



Building stronger connections with an unwavering commitment to customer satisfaction.

# GUIDE TO APPLICATION & ROPE SELECTION

DOCK-SIDE / DECK CRANES / OFF-SHORE PEDESTAL	TOWER CRANES	MOBILE AND CRAWLER CRANES	CONTAINER CRANES / UNLOADERS	PILLING	LADLE CRANES
--	--------------	---------------------------	------------------------------	---------	--------------

TYPICAL APPLICATIONS



	MAIN HOIST	BOOM HOIST	WHIP HOIST	MAIN HOIST	STAY	TROLLEY	MAIN HOIST	BOOM HOIST	MAIN HOIST	BOOM HOIST	TROLLEY/RACKING	HOIST	HOIST
HYFLEX 6/6P POWERFORM® 6/6P	✗	✓	✗	✗	✓	✓	✗	✓	✓	✓	✓	!	✓
HYFLEX 8/8P POWERFORM® 8/8P	!	✓	✗	✗	✓	✓	✗	✓	✓	✓	✓	✗	✓
HYFLEX 4	✓	✗	✗	✗	✗	✗	✓	✗	✗	✗	✗	!	✗
HYFLEX 18/18P POWERFORM® 18/18P	✓	✗	✓	✓	✗	✗	✓	✗	✗	✗	✗	✓	✗
HYFLEX 35/35P POWERFORM® 35/35P	✓	✗	✓	✓	✗	✗	✓	✗	✗	✗	✗	✓	✗

Key: ✓ Recommended    ! Allowed    ✗ Not Recommended



# HYFLEX

**Non Compacted**

**Lay direction**

LH or RH

**Lay Type**

Ordinary or Langs

**Finish**

Bright or Galvanised

## HYFLEX 6 / 6P

NOMINAL ROPE DIAMETER		APPROX. MASS		MINIMUM BREAKING LOAD		
				1770 GRADE	1960 GRADE	2160 GRADE
mm	inch	kg/m	lb/ft	kN	kN	kN
8		0.273	0.184	43.3	47.9	52.8
9		0.346	0.233	54.8	60.6	66.8
10		0.427	0.287	67.6	74.9	82.5
11		0.517	0.347	81.8	90.6	100
12		0.615	0.413	97.4	108	119
	1/2	0.689	0.463	109	121	133
13		0.722	0.485	114	127	139
14		0.837	0.563	133	147	162
	5/8	1.08	0.726	171	190	209
16		1.10	0.739	174	192	212
17		1.24	0.833	197	218	240
18		1.39	0.934	220	244	269
19		1.55	1.04	246	272	300
20		1.72	1.16	272	301	332
22		2.08	1.40	329	365	402
	7/8	2.12	1.42	336	372	410
24	15/16	2.48	1.67	392	434	478
25		2.69	1.81	425	471	519
	1	2.77	1.86	438	485	535
26		2.91	1.96	460	509	561
28		3.37	2.26	533	591	651
	1 1/8	3.51	2.36	556	615	678
30		3.87	2.60	612	678	747
	1 1/4	4.33	2.91	686	760	837
32		4.40	2.96	697	771	850
36		5.57	3.74	876	970	1069
40		6.88	4.62	1082	1198	1320
44		8.32	5.59	1270	1406	1549
48	1 7/8	9.90	6.65	1511	1673	1844
52		11.6	7.81	1773	1964	2164
56		13.5	9.05	2056	2277	2510
60	2 3/8	15.5	10.4	2361	2614	2881

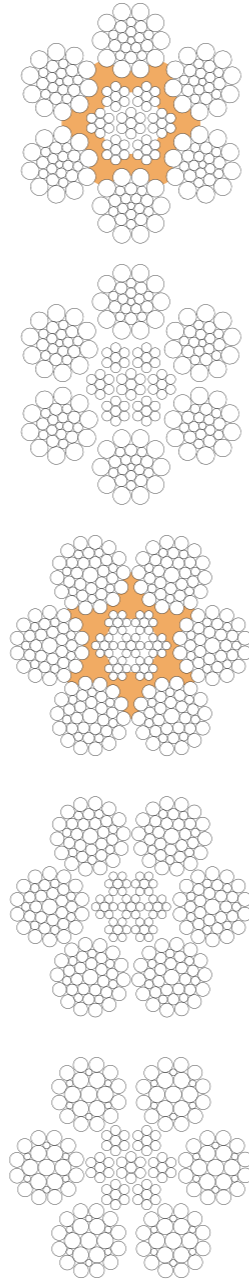

- Excellent shock resistance
- Enhanced resistance to fleet angle if plastic impregnated

## HYFLEX 8 / 8P

NOMINAL ROPE DIAMETER		APPROX. MASS		MINIMUM BREAKING LOAD	
				1960 GRADE	2160 GRADE
mm	inch	kg/m	lb/ft	kN	kN
10		0.435	0.292	72.9	81.4
11		0.526	0.353	86.1	96.5
12		0.626	0.421	105	117
	1/2	0.702	0.472	123	131
13		0.735	0.494	124	138
14		0.853	0.573	143	160
15		0.979	0.658	164	183
16	5/8	1.11	0.746	187	208
17		1.26	0.847	211	239
18		1.41	0.947	239	267
19	3/4	1.57	1.05	269	300
20		1.76	1.18	295	331
22		2.13	1.43	356	400
	7/8	2.17	1.46	360	402
24		2.53	1.70	423	475
25		2.75	1.85	459	506
	1	2.84	1.91	470	525
26		2.97	2.00	500	562
28		3.45	2.32	572	642
	1 1/8	3.59	2.41	596	665
30		3.96	2.66	656	733
32	1 1/4	4.51	3.03	747	836
34		5.09	3.42	843	945
36		5.70	3.83	935	1053
38	1 1/2	6.35	4.27	1043	1172
40		7.04	4.73	1162	1313
42		7.85	5.27	1305	1462
44		8.62	5.79	1412	1577
	1 3/4	8.79	5.91	1441	1613
46		9.42	6.33	1543	1731
48		10.3	6.89	1680	1885
50		11.1	7.48	1833	2065
	2	11.5	7.71	1882	2101
52		12.0	8.08	1972	2202

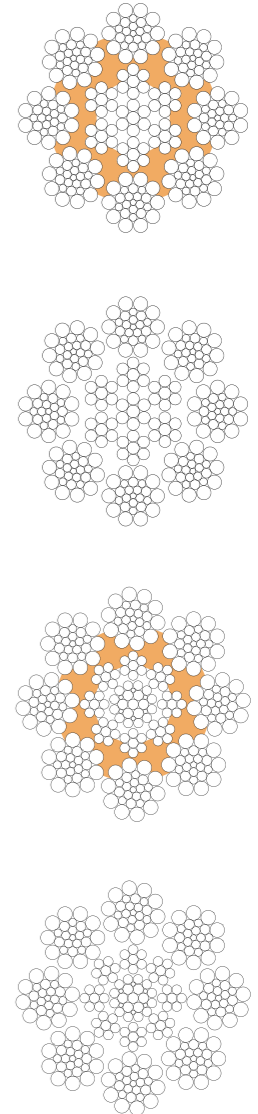

- Enhanced resistance to fleet angle if plastic impregnated
- Greater surface contact area resulting from the eight strand construction

## HYFLEX 35 / 35P

NOMINAL ROPE DIAMETER		APPROX. MASS		MINIMUM BREAKING LOAD	
mm	inch	kg/m	lb/ft	1960 GRADE kN	2160 GRADE kN
10		0.448	0.301	76.0	86.5
11		0.542	0.364	91.0	104
12		0.645	0.434	107	125
	1/2	0.723	0.486	123	137
13		0.757	0.509	128	146
14		0.878	0.590	148	168
15		1.01	0.677	170	194
	5/8	1.13	0.759	190	218
16		1.15	0.771	194	221
17		1.29	0.870	219	247
18		1.45	0.975	242	277
19	3/4	1.63	1.09	277	312
20		1.79	1.20	301	337
21		1.98	1.33	335	370
22		2.17	1.46	370	412
	7/8	2.21	1.49	376	418
24		2.58	1.73	441	498
25		2.80	1.88	479	540
	1	2.89	1.94	491	546

## HYFLEX 35 / 35P

NOMINAL ROPE DIAMETER		APPROX. MASS		MINIMUM BREAKING LOAD	
mm	inch	kg/m	lb/ft	1960 GRADE kN	2160 GRADE kN
26		3.03	2.04	517	581
28		3.51	2.36	599	681
	1 1/8	3.66	2.46	621	704
30		4.03	2.71	679	775
	1 1/4	4.52	3.03	761	865
32		4.59	3.08	769	865
35	1 3/8	5.47	3.67	945	1044
36		5.81	3.90	983	1085
38	1 1/2	6.50	4.37	1078	1205
40		7.17	4.82	1202	1335
42		7.90	5.31	1227	1352
44		8.67	5.83	1347	1484
	1 3/4	8.85	5.95	1375	1515
46		9.48	6.37	1472	1622
48		10.3	6.94	1603	1766
50		11.2	7.53	1740	1917
	2	11.6	7.77	1796	1979
52		12.1	8.14	1881	2072

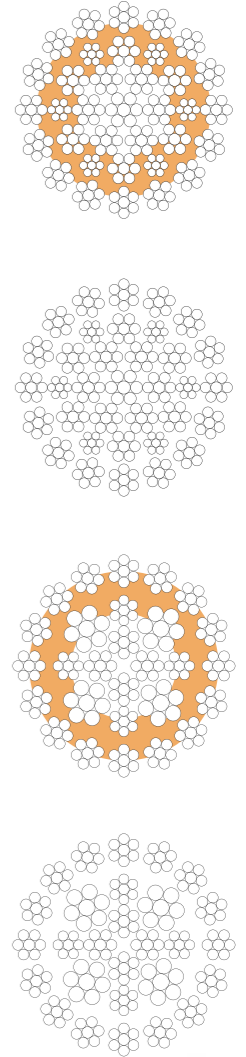

- Excellent non-rotational properties
- High flexibility and handling properties
- High resistance to side pressure and crushing

## HYFLEX 4

NOMINAL ROPE DIAMETER	APPROX. MASS		MINIMUM BREAKING LOAD	
			1770 GRADE	1960 GRADE
mm	kg/m	lb/ft	kN	kN
16	1.09	0.731	160	177
18	1.38	0.925	203	225
20	1.70	1.14	250	277
22	2.06	1.38	303	335
24	2.45	1.64	360	399
25	2.66	1.78	391	433
26	2.87	1.93	423	468
28	3.33	2.24	490	543
30	3.83	2.57	564	624
32	4.35	2.92	641	710
33.5	4.77	3.20	703	778
34	4.91	3.30	723	801
35.5	5.36	3.60	788	873
36	5.51	3.70	811	898
38	6.14	4.12	904	1001

- Torque balanced rope

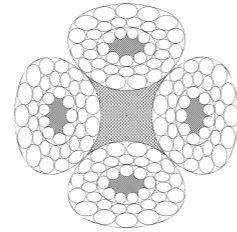

## HYFLEX 18

NOMINAL ROPE DIAMETER		APPROX. MASS		MINIMUM BREAKING LOAD	
				1960 GRADE	2160 GRADE
mm	inch	kg/m	lb/ft	kN	kN
6		0.157	0.105	25.0	27.0
7		0.213	0.143	34.0	37.0
8		0.278	0.187	45.0	49.0
9		0.352	0.237	57.0	61.0
10		0.435	0.292	70.0	76.0
11		0.526	0.354	84.0	91.0
12		0.626	0.421	101	109
	1/2	0.702	0.471	113	121
13		0.735	0.494	118	127
14		0.853	0.573	137	148
15		0.979	0.658	157	169
16	5/8	1.11	0.748	180	194
17		1.26	0.845	203	219
18		1.41	0.947	226	244
	3/4	1.58	1.06	253	273
20		1.74	1.17	279	301
22		2.11	1.41	339	366
	7/8	2.15	1.44	346	374

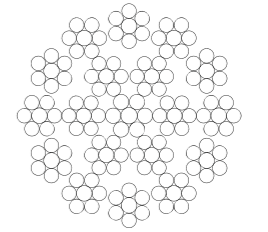

- Good resistance to rotation
- High flexibility and handling properties



# POWERFORM<sup>®</sup>

**Compacted**

**Lay direction**

LH or RH

**Lay Type**

Ordinary or Langs

**Finish**

Bright or Galvanised

## POWERFORM® COMPACTED ROPE



Conventional Strand

Conventional Rope

A Powerform® compacted rope is a steel wire rope which has been manufactured using individually compacted strands.

During the compaction process the outside diameter of the strand is reduced and steel moves into the empty voids between the wires within the strand.

The forming process also produces a very smooth exterior strand surface.

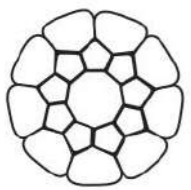

Compacted Strand

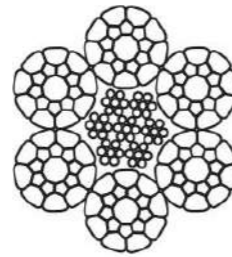

Compacted Rope

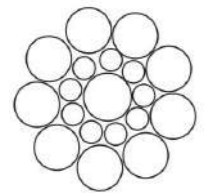

Conventional

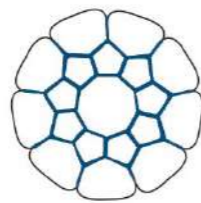

Compacted

The compacted strand has very favourable internal contact conditions when compared with the point contact of round wires within a normal strand.



Conventional



Compacted

Exterior contact conditions are equally favourable. The smooth surface of the compacted rope offers a wider bearing surface to the sheave or drum groove.

Inter strand contact and contact between adjacent laps of rope on the winch drum is also improved.

## POWERFORM® SELECTION

### Optimised crane design

The breaking load to size relationship can allow crane manufacturers to optimise the design of crane components such as the winch drum and sheaves whilst still complying with international crane design standards.

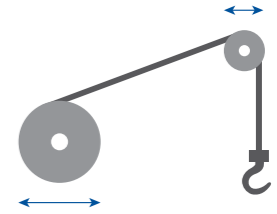

### Longer Life

Laboratory fatigue testing indicates that it is possible to achieve a significant increase in rope life when comparing a Powerform® rope with a conventional rope of equivalent construction.

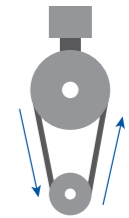

### Greater resistance to crushing in multi-layer coiling situations

Powerform® ropes are recommended for all multi-layer coiling situations where crushing on lower layers is inevitable. The more solid cross section of the Powerform® rope offers much greater resistance to this type of damage.

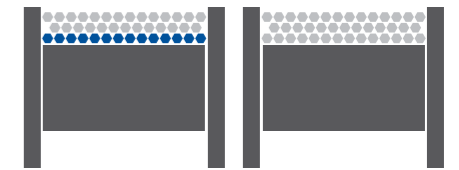

### More effective resistance to crushing at crossover points

Because of the higher steel fill factor Powerform® ropes offer much better resistance to crushing damage at crossover points on the winch drum.

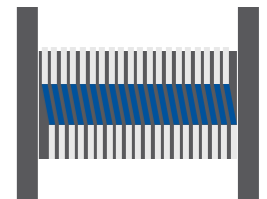

### Greater resistance to “side crushing” at the drum

Abrasive wear between adjacent laps of rope which is normally most severe where the rope moves on and off the drum can be minimised by using a Powerform® rope.

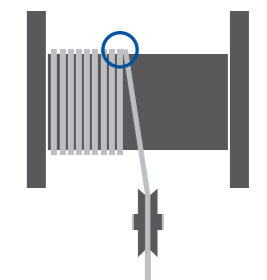

### Reduced wear on sheaves

The smooth exterior of the Powerform® rope can lead to reduced abrasive wear on both the sheave and rope.

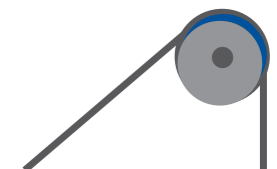

# POWERFORM® 6 / 6P

NOMINAL ROPE DIAMETER		APPROX. MASS		MINIMUM BREAKING FORCE		
mm	inch	kg/m	lb/ft	1770 GRADE kN	1960 GRADE kN	2160 GRADE kN
10		0.460	0.309	75.4	83.5	92.0
11		0.557	0.374	91.0	101	111
12		0.662	0.445	108	120	132
	1/2	0.742	0.499	121	134	148
13		0.777	0.522	127	141	155
14		0.902	0.606	148	163	180
15		1.04	0.699	170	188	207
	5/8	1.16	0.779	190	211	232
16		1.18	0.793	193	214	236
17		1.33	0.894	218	241	266
18		1.49	1.00	244	270	298
19	3/4	1.66	1.12	272	301	332
20		1.84	1.24	302	334	368
22		2.23	1.50	365	404	445
	7/8	2.27	1.53	372	412	454
24		2.65	1.78	434	481	530
25		2.88	1.94	471	522	575
	1	2.97	2.00	487	539	594

# POWERFORM® 6 / 6P

NOMINAL ROPE DIAMETER		APPROX. MASS		MINIMUM BREAKING FORCE		
mm	inch	kg/m	lb/ft	1770 GRADE kN	1960 GRADE kN	2160 GRADE kN
26		3.11	2.09	510	564	622
28		3.61	2.43	591	654	721
	1 1/8	3.76	2.53	615	681	751
30		4.14	2.78	679	751	828
	1 1/4	4.54	3.05	760	841	927
32		4.61	3.10	764	846	932
34		5.20	3.49	860	953	1050
35	1 3/8	5.49	3.69	910	1007	1110
36		5.83	3.92	967	1071	1180
38	1 1/2	6.50	4.37	1073	1189	1310
40		7.20	4.84	1196	1325	1460
42		7.94	5.34	1319	1461	1610
44		8.71	5.85	1442	1597	1760
	1 3/4	8.89	5.97	1475	1633	1800
46		9.52	6.40	1582	1751	1930
48	1 7/8	10.4	6.99	1721	1906	2100
50		11.3	7.59	1868	2069	2280
	2	11.6	7.79	1926	2132	2350
52		12.2	8.20	2016	2232	2460
54	2 1/8	13.1	8.80	2172	2405	2650
56		14.1	9.47	2335	2586	2850
58		15.1	10.1	2508	2777	3060
60	2 3/8	16.4	11.0	2712	3004	3310

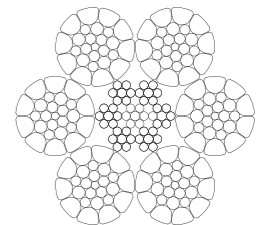
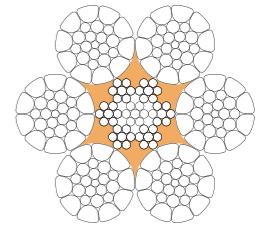

- Improved MBF
- Excellent shock resistance
- Good resistance to side pressure and crushing
- Enhanced resistance to fleet angle if plastic impregnated

## POWERFORM® 8 / 8P

NOMINAL ROPE DIAMETER		APPROX. MASS		MINIMUM BREAKING FORCE	
mm	inch	kg/m	lb/ft	1960 GRADE kN	2160 GRADE kN
10		0.460	0.309	87.8	94.0
11		0.557	0.374	106	114
12		0.662	0.445	126	135
	1/2	0.742	0.499	142	152
13		0.777	0.522	148	159
14		0.902	0.606	172	184
15		1.04	0.695	198	211
16	5/8	1.18	0.791	225	241
17		1.33	0.893	254	272
18		1.49	1.00	284	304
19	3/4	1.66	1.12	317	339
20		1.84	1.24	351	376
22		2.23	1.50	425	455
	7/8	2.27	1.53	434	464
24		2.65	1.78	506	541
	1	2.97	1.99	567	606



## POWERFORM® 8 / 8P

NOMINAL ROPE DIAMETER		APPROX. MASS		MINIMUM BREAKING FORCE	
mm	inch	kg/m	lb/ft	1960 GRADE kN	2160 GRADE kN
26		3.11	2.09	594	635
28		3.61	2.42	688	737
	1 1/8	3.76	2.52	717	767
30		4.14	2.78	790	846
32	1 1/4	4.71	3.17	899	960
34		5.32	3.57	1013	1083
36		5.96	4.01	1138	1218
38	1 1/2	6.64	4.46	1268	1357
40		7.36	4.95	1405	1503
42		8.11	5.45	1535	1651
44		8.91	5.98	1700	1819
	1 3/4	9.09	6.11	1735	1856
46		9.73	6.54	1858	1985
48		10.6	7.12	2023	2162
50		11.5	7.73	2200	2349
	2	11.9	7.98	2266	2425
52		12.4	8.36	2374	2541

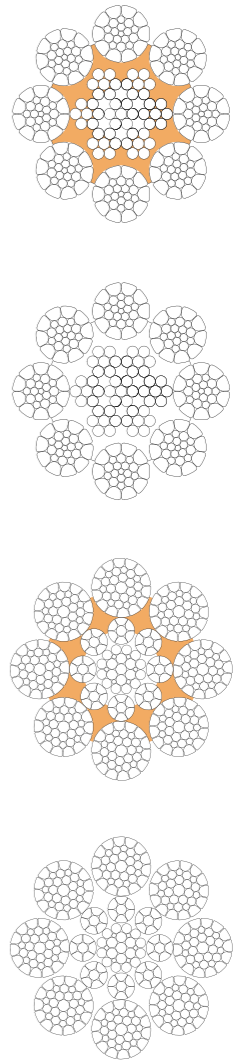

- High MBF
- Enhanced resistance to fleet angle if plastic impregnated
- Smoother contact surface in respect to conventional hoist rope

**NOTE:**  
Rope wt. mentioned above is correspondence to the 1960 grade.  
For 2160 grade, Rope wt. will be approx. 5% higher.

## POWERFORM® 8 MAX

NOMINAL ROPE DIAMETER		APPROX. MASS		MINIMUM BREAKING FORCE
mm	inch	kg/m	lb/ft	2160 GRADE
10		0.490	0.329	102
11		0.593	0.398	123
12		0.706	0.474	147
		0.790	0.531	165
13		0.828	0.556	172
14		0.960	0.645	200
15		1.10	0.739	230
	5/8	1.23	0.827	257
16		1.25	0.840	261
17		1.42	0.954	295
18		1.59	1.07	331
19	3/4	1.77	1.19	368
20		1.96	1.32	408
22		2.37	1.59	494
	7/8	2.42	1.63	504
24		2.82	1.89	588
25		3.06	2.06	638
	1	3.16	2.12	658
26		3.31	2.22	690
28		3.84	2.58	800
	1 1/8	4.00	2.69	833
30		4.41	2.96	918
	1 1/2	4.94	3.32	1030

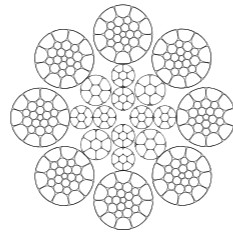

- Extremely high MBF
- High resistance to side pressure and crushing

## POWERFORM® 18

NOMINAL ROPE DIAMETER		APPROX. MASS		MINIMUM BREAKING FORCE	
mm	inch	kg/m	lb/ft	1960 GRADE	2160 GRADE
6		0.175	0.118	29.4	
7		0.238	0.160	38.0	
8		0.310	0.208	51.8	
9		0.393	0.264	64.6	
10		0.485	0.326	80.8	
11		0.587	0.394	101	111
12		0.698	0.469	116	127
	1/2	0.782	0.525	135	148
13		0.820	0.551	141	155
14		0.951	0.639	160	177
15		1.09	0.732	182	201
16	5/8	1.24	0.833	209	232
17		1.40	0.941	237	262
18		1.57	1.05	266	295
	3/4	1.75	1.18	291	322
20		1.94	1.30	320	359
22		2.35	1.58	379	424
24		2.79	1.87	462	523
	1	3.13	2.10	517	585
26		3.28	2.20	542	613
28		3.80	2.55	632	710
30		4.37	2.94	721	809
32	1 1/4	4.97	3.34	820	920

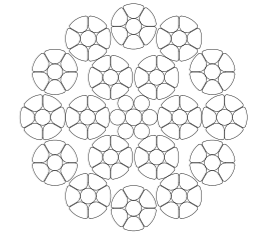

- Good rotational stability
- Good resistance to side pressure and crushing

# POWERFORM® 35 / 35P

NOMINAL ROPE DIAMETER		APPROX. MASS		MINIMUM BREAKING FORCE	
mm	inch	kg/m	lb/ft	1960 GRADE kN	2160 GRADE kN
10		0.490	0.329	91.0	100
11		0.593	0.398	111	121
12		0.706	0.474	131	144
	1/2	0.790	0.531	148	161
13		0.828	0.556	155	169
14		0.960	0.645	180	196
15		1.10	0.739	207	225
	5/8	1.23	0.827	234	252
16		1.25	0.840	238	256
17		1.42	0.954	269	289
18		1.59	1.07	301	324
19	3/4	1.81	1.22	336	361
20		2.00	1.34	372	400
22		2.42	1.63	450	484
	7/8	2.47	1.66	459	494

# POWERFORM® 35 / 35P

NOMINAL ROPE DIAMETER		APPROX. MASS		MINIMUM BREAKING FORCE	
mm	inch	kg/m	lb/ft	1960 GRADE kN	2160 GRADE kN
24		2.88	1.94	536	576
25		3.13	2.10	581	625
	1	3.23	2.17	600	645
26		3.38	2.27	629	676
28		3.92	2.63	729	788
	1 1/8	4.08	2.74	759	817
30		4.50	3.02	837	904
	1 1/4	5.04	3.39	937	1010
32		5.12	3.44	952	1040
34		5.78	3.88	1080	1160
35	1 3/8	6.10	4.10	1130	1220
36		6.48	4.35	1210	1300
38	1 1/2	7.22	4.85	1340	1440
40		8.00	5.38	1490	1600
42		8.82	5.93	1643	
44		9.68	6.50	1803	
	1 3/4	9.90	6.65	1840	
46		10.6	7.11	1971	
48		11.5	7.74	2146	
50		12.5	8.40	2328	
	2	12.9	8.67	2403	
52		13.5	9.09	2518	
60		18.0	12.1	3353	
64		20.5	13.8	3814	
66		21.8	14.6	4057	

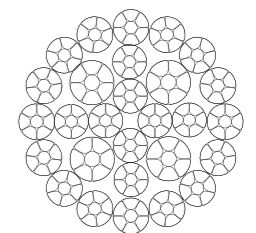
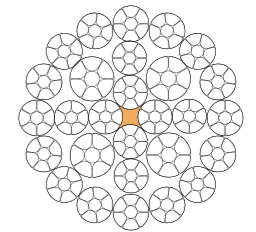
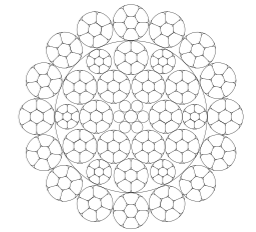
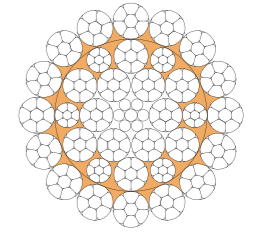

- Extremely high MBF
- Excellent non-rotational properties
- High fatigue life and increased abrasion
- Enhanced resistance to fleet angle if plastic impregnated

## STORAGE & PRE-INSTALLATION PROCEDURE

Crane ropes, like any machine or spares, deteriorate during storage as well as in service. Therefore, the assurance of safety and economy in use of the equipment, dictates the requirement for a procedure of proper storage, handling and installation of crane ropes.

### STORAGE

- Store rope in a clean, dry, well ventilated, dust free undercover location.
- Cover the rope with water proof material and/or canopy, if not stored inside.
- Storage should be free from steam, chemical fumes or any other corrosive agent.
- Avoid direct contact of rope with floor.
- Place reels, preferably over a frame or cradle and allow flow of air under the reel.
- Avoid rope exposure to elevated temperatures.
- Avoid handling damages to wire ropes.
- Ensure that tag/markings is intact and follow 'first in, first out' principle.
- Inspect rope periodically and apply suitable rope dressing compatible with manufactured lubricant, whenever necessary.
- Rotate reel periodically, say after every 3 months, particularly in warm environment.

### BEFORE INSTALLATION

- Before re-equipping the appliance, all grooves in drums and pulleys should be checked to ensure that they will correctly accept the replacement rope.
- Sheave groove diameter should be larger than the nominal rope diameter by about 5% to 10% and ideally at least 2.5% greater than the actual diameter of the new rope.
- The diameter of the new rope shall be measured with the rope under no tension and the value recorded. Maintain fleet angle at minimum during installation
- Prior to rope cutting, always follow proper procedure of rope seizing
- Never pull the rope from stationary coil or reel
- Avoid contact with ground while unwinding the rope
- Keep the reel on a suitable stand with braking arrangement
- Avoid formation of kink/ bends in the rope during handling
- Follow 'top to top' or 'bottom to bottom' practice for rope transfer from reel to drum / winch.

### RUNNING IN PROCEDURE

- Run the newly installed wire rope in and out six times over its maximum working length with a load approx. 25% of safe working load at reduce speed.
- Repeat this procedure with load at 50% of safe working load.
- Continue the same procedure with load at 100% of safe working load.

### SEIZING PROCEDURE

The purpose of seizing a rotation resistant wire rope is to prevent relative movement of individual strands of inner core as well as outer layer and thereby preserving its designed integrity and rotational balance. Therefore, before cutting any rotation resistant wire rope, tightly double seize with soft steel wire of suitable size, on either side of the intended cut. The length of each seizing should be at least equal to  $2 \times d_{\text{rope dia}}$  and each of the seizing should be spaced approximately  $6 \times d_{\text{rope dia}}$

- Use of adhesive tape in lieu of seizing is strictly discouraged.
- Fusing of cut ends is strongly recommended.

#### POWERFORM® 18/HYFLEX 18 | POWERFORM® 35/HYFLEX 35

For 6.0 mm to 24.0 mm wire rope, use 1.0 mm wire  
 For 25.0 mm to 36.0 mm wire rope, use 1.6 mm wire  
 For 37.0 mm to 56.0 mm wire rope, use 2.0 mm wire  
 Double seizing and end fusing mandatory

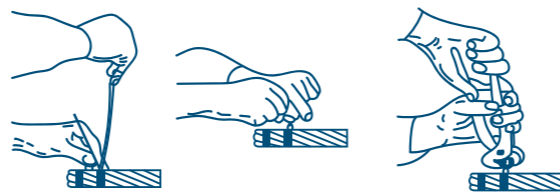

## HANDLING & INSTALLATION

### 6/8 STRANDED ROPE

- Never pull out rope from stationary coil.
- Place rope reel on ground and roll out straight.
- If heavy, place coil on turntable and pull the end away from coil.
- Prevent contamination with dust, grit, moisture, chemicals and other harmful material.
- Put a shaft of adequate strength through reel bore and place in a suitable stand.
- Allow reel to rotate freely and be braked to avoid overrun.
- Provide back tension for multilayer spooling and ensure to wind tightly, particularly the bottom layer.
- Maintain constant tension while reeving and avoid layer cross-over.
- Avoid formation of loops or kinks.
- Avoid reverse bending during reeving. Wind/Unwind 'top to top' or 'bottom to bottom'.
- Take special care while releasing the outboard end of rope from supplied reel or coil.
- Maintain fleet angle at minimum during installation.
- Check that the grooves of all sheaves are as recommended and sheaves are free to rotate.
- Check the diameter and pitch of drum grooves, and ensure that these are as recommended.
- 'Run' the new rope by running the equipment slowly, with a low load for a number of cycles.
- Inspect that the rope spools correctly on the drum and no slackness or cross-over occurs.



#### NOTE:

The user should always refer relevant standard/regulations like EN-12385, ISO 4309 for wire rope care, maintenance & installation.

# HANDLING & INSTALLATION

## HANDLING OF MULTI-STRAND ROTATION RESISTANT ROPES:

Since rotation resistance wire ropes have special layering and arrangements of strands that are very sensitive, therefore they require careful handling and installation in order to avoid deterioration, hoisting problems and premature removal of wire ropes. The recommendations are given below to be followed in addition to the general mentioned method.

- The rope should be paid off in the correct manner to ensure that the turn is neither put in nor taken out.
- A small rope of short length, say up to 100 mtr, may be unrolled along the ground but should always be kept under control. Never pull a rope from a stationary coil.
- Ropes in larger sizes or longer lengths should always be procured on reels, and transferring these to coils should be avoided.
- A long length of rope on a reel has a high moment of inertia. Proper braking arrangements must be made to prevent overrun, which may lead to loop formation. A simple braking mechanism consists of a wooden plank acting against the reel flange.
- If, for any reason a loop does form, ensure that this does not tighten to cause a kink, which may lead to distortion of the rope, requiring its immediate discard.
- The rope should be smoothly paid out in a straight line from the reel, mounted on a stand and supported by a shaft. If the space available does not permit the same, the reel and stand must be placed to limit the fleet angle of installation to 1° 30, i.e., for 1 mtr width between flanges to 40 mtr of horizontal distance. If space allows for a longer run, then it can be used with advantage.
- Care should be taken to avoid the reel being placed in such a position that will set up a reverse bend during reeving, i.e., for an under-winding drum, the rope should be taken off the bottom of the reel.
- Multi-strand ropes are generally supplied with fixed ends, unless otherwise specified. If, for any reason, it is necessary to cut a rope at the site, at least three tight servings of soft seizing wire should be applied on either side before cutting.

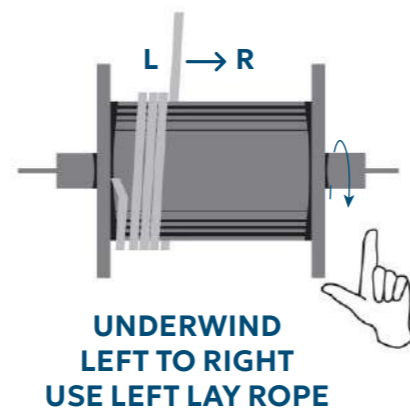
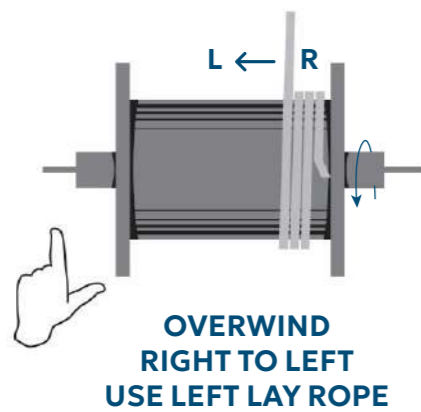
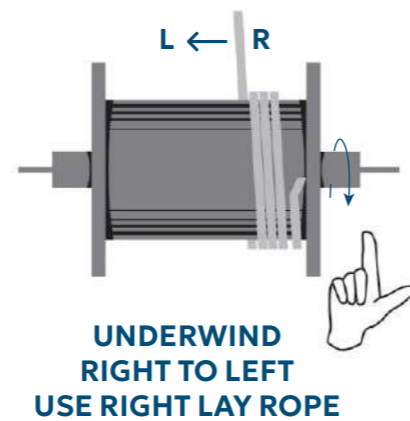
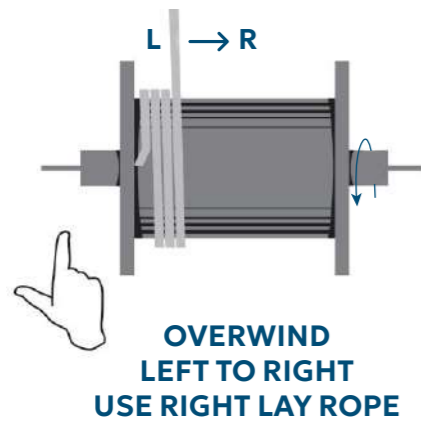

# DISCARD CRITERIA

Crane ropes must be removed from service if the examination reveals that the rope deterioration has exceeded limits of certain criteria. A general retirement plan states that one of the factors listed below, severe enough, can cause rope discard. However, rope deterioration and decision to discard, almost always, is the result of cumulative effect of combination of these factors.

Broken Wires | Diameter Reduction | Corrosion | Deformation

## NUMBER & CHARACTERISTICS OF BROKEN WIRES

Crane rope must be considered for discard if number of visible broken wires equals or exceeds the allowable limit. For 6 and 8 strand wire ropes, occurrence of wire breakages, to a large extent is on the outer surface, whereas for rotation-resistant wire ropes, majority of wire breakages are expected to occur internally and require specialized examination techniques to reveal.

The table below specifies the number of visible broken wires, which when equalled or exceeded requires mandatory discard of ropes working on steel sheaves.



**VALLEY WIRE BREAKAGE**



**CROWN WIRE BREAKAGE**

- Wire breaks in the strand valley, generally, indicate internal rope deterioration and require closer inspection of the rope equal to 6 x d.
- Broken wires at, or adjacent to the termination, require the termination to be remade by shortening the rope, otherwise the rope should be discarded.
- Concentrated close group of broken wires in a rope length of 6 x d or in any one strand, requires discard of the rope even if the number given above are not reached.
- Complete fracture of one strand or collapse of core requires immediate discard of the wire rope.

PRODUCT	CONSTRUCTION	SECTION OF ROPE WORKING IN STEEL SHEAVES AND / OR SPOOLING ON A SINGLE LAYER DRUM				SECTION OF ROPE SPOOLING ON A MULTI-LAYER DRUM			
		NO. OF VISIBLE BROKEN WIRES IN WIRE ROPE LENGTH EQUALS				NO. OF VISIBLE BROKEN WIRES IN WIRE ROPE LENGTH			
		(ORDINARY LAY)		(LANGS LAY)		(ORDINARY LAY)		(LANGS LAY)	
		6 x d	30 x d	6 x d	30 x d	6 x d	30 x d	6 x d	30 x d
HYFLEX 4	4X39	2	4	2	4	4	8	4	8
	6X25F	5	10	2	5	10	20	10	20
HYFLEX 6/ POWERFORM® 6	6X29F	6	11	3	6	12	22	12	22
	6X26WS	6	13	3	6	12	26	12	26
	6X31WS	8	16	4	8	16	32	16	32
	6X36WS	9	18	4	9	18	36	18	36
	6X41WS	10	21	5	10	20	42	20	42
HYFLEX 8/ POWERFORM® 8	8X25F	6	13	3	6	12	26	12	26
	8X26WS	9	18	4	9	18	36	18	36
	8X31WS	10	21	5	10	20	42	20	42
	8X36WS	12	24	6	12	24	48	24	48
	8X41WS	13	26	6	13	26	52	26	52
HYFLEX 18/ POWERFORM® 18	18X7	2	4	2	4	4	8	4	8
	18X19S	4	8	4	8	8	16	8	16
	18X26WS	6	12	6	12	12	24	12	24
HYFLEX 35/ POWERFORM® 35	35X7	3	5	3	5	5	10	5	10
	35X19S	6	12	6	12	12	24	12	24
	35X26WS	6	12	6	12	12	24	12	24

# RECOMMENDED DO'S & DON'TS

## DO'S

- Lubricate ropes with good quality acid free and moisture free lubricant
- Regularly inspect the sheaves, rollers or pulleys - the life of a rope largely depends on their conditions
- Inspect ropes and fittings/terminations periodically

## DON'TS

- Do not allow ropes in store to deteriorate
- Do not mishandle ropes when uncoiling or unreeling & allow kinks to form
- Do not use lang's lay with swivel for 6/8 standard rope
- Do not use a rope with too large groove diameter on drums and pulleys
- Do not cut a rope without seizing
- Do not load the rope beyond its safe working load. Reduction of safety factor may jeopardise not only rope, but also equipment, job and men

METRIC – IMPERIAL DIAMETER CONVERSION											
inch	mm	inch	mm	inch	mm	inch	mm	inch	mm	inch	mm
5/32	3.97	1/2	12.7	15/16	23.8	1 1/2	38.1	2 1/2	63.5	4 1/4	108.0
3/16	4.76	9/16	14.3	1	25.4	1 5/16	41.3	2 3/4	69.9	4 1/2	114.3
7/32	5.56	5/8	15.9	1 1/16	27.0	1 3/4	44.5	3	76.2	4 3/4	120.7
1/4	6.35	11/16	17.5	1 1/8	28.6	1 7/8	47.6	3 1/4	82.6	5	127.0
5/16	7.94	3/4	19.0	1 3/16	30.2	2	50.8	3 1/2	88.9		
3/8	9.53	13/16	20.6	1 1/4	31.8	2 1/8	54.0	3 3/4	95.3		
7/16	11.1	7/8	22.2	1 3/8	34.9	2 1/4	57.2	4	101.6		

CONVERSION TABLE				
Length	1m	= 1000mm	= 3.281ft	= 39.37 inch
Force	1kN	= 101.97kp	= 0.10197 t metric-f	= 224lbs-f
Tensile Strength	1N/mm <sup>2</sup>	= 0.10197 kp/mm <sup>2</sup>	= 145.04 p.s.i.	= 10 bar
Cross Section	1 mm <sup>2</sup>	= 0.00155 sq.inch		
Weight	1 metric t	= 1000kg = 1.102 short t	= 0.9842 long t	= 2204.6 lbs
Weight per Length Unit	1 kg/m	= 0.672 lbs/ft		



## CORPORATE OFFICE

### USHA MARTIN LIMITED

2A, Shakespeare Sarani 'Mangal Kalash'  
Kolkata-700 071  
Phone: +91 33 71006300 / +91 33 71006492  
Email: contact@ushamartin.co.in

## INDIA OFFICES

### NORTH REGIONAL OFFICE

#### USHA MARTIN LIMITED

825 & 826, 8th Floor,  
World Trade Tower  
Plot-1, Block- B, Sector-16, Noida, U.P. – 201301  
Phone: +91 120 6286129  
Email: marketing-north@ushamartin.co.in

### EAST REGIONAL OFFICE

#### USHA MARTIN LIMITED

2A, Shakespeare Sarani 'Mangal Kalash'  
Kolkata – 700071  
Phone: +91 33 71006492  
Email: marketing-east@ushamartin.co.in

### SOUTH REGIONAL OFFICE

#### USHA MARTIN LIMITED

VKR Tower, No. 14, First Avenue, Ground Floor,  
Ashok Nagar, Chennai - 600083  
Phone: +91 44 47885020  
Email: marketing-south@ushamartin.co.in

### WEST REGIONAL OFFICE

#### USHA MARTIN LIMITED

Office No. 1001/1002, Chandak Chambers,  
Near WEH Metro Station, Andheri Kurla Road,  
Andheri (E), Mumbai – 400 069  
Phone: +91 22 6239 0290  
Email: marketing-west@ushamartin.co.in

## INTERNATIONAL OFFICES

### USHA MARTIN AMERICAS, INC

1301 Hays Street  
Houston, TX 77009  
Phone: +1 713 676 1800  
Email: sales@ushamartinus.com

### USHA MARTIN UK LIMITED

Sandy Lane, Worksop,  
Nottinghamshire, S80 3ES, UK  
Phone: +44 01909 537 645  
Email: info@ushamartin.co.uk

### EMM CORP

Howe Moss Place,  
Kirkhill Industrial Estate Dyce,  
Aberdeen AB 21 OGS, Scotland, UK  
Phone: +44 1224 77 5151  
Email: info@emmcop.com

### BRUNTON SHAW UK

Sandy Lane, Worksop, S80 3ES, UK  
Phone: + 44 1909 537 600  
Email: info@brunton-shaw.co.uk

### DE RUITER STAALKABEL B.V.

Kerkeplaat 10, 3313 LC Dordrecht  
The Netherlands  
Phone: +31 (0) 78 – 8200600  
Email: info@drstk.nl

### USHA MARTIN EUROPE B.V.

Kerkeplaat 10  
3313 LC Dordrecht The Netherlands  
Phone: +31 (0) 180 – 745099  
Email: info@ushamartineurope.com

### BRUNTON WIRE ROPES FZCO.

P.O. Box 17491, M00301  
Jebel Ali Free Zone, Dubai U.A.E  
Phone: + 971 50 4503717  
Email: sm@bsme-uae.com

### EMM CORP SAUDI ARABIA

Brunton Wire Ropes Industrial Company Limited  
P3511 Al Ameer Sultan–Al Jawharah Dist.  
Unit No.15, Al Khobar 34434-9497,  
Kingdom of Saudi Arabia  
Phone: +966 138126266  
Email: rahat@emm-saudi.com

### USHA SIAM STEEL INDUSTRIES PUBLIC COMPANY LIMITED

66 Q House Asoke Building,  
12th Floor, Unit 1207 Sukhumvit 21 road,  
North Klongtoey, Wattana, Bangkok 10110  
Phone: +662 261 7361- 4  
E-mail: info@ushasiam.com

### USHA MARTIN SINGAPORE PTE LIMITED

91 Tuas Bay Drive, Usha Martin Building,  
Singapore – 637307  
Phone: +65 6265 7756  
Email: sales@umsingapore.com

### USHA MARTIN AUSTRALIA PTY LTD

Sydney Office: 199, Hassall Street,  
Wetheril Park, NSW 2164  
Phone: +61 411 095 983  
Perth Office: 31 Colin Jamieson Drive,  
Welshpool WA 6106 Phone: +61 419 939 567  
Email: marketing-australia@ushamartin.co.in

### USHA MARTIN VIETNAM CO. LTD

18A, D2 Street, Ward 25,  
Binh Thanh District, Ho Chi Minh City,  
S.R Vietnam  
Phone: +84 28 3512 2209  
Email: qui@umvietnam.com.vn

### PT. USHA MARTIN INDONESIA

Konica Building 3A Floor Jl.  
Gunung Sahari Raya 78 Jakarta 10610,  
Indonesia  
Phone: +62 21 42870794  
Email: marketing-indonesia@ushamartin.co.in

### USHA MARTIN ITALIA S.R.L

Via Antonio Segni 6  
25062 Concesio (BS), Italy.  
Phone: +39 030 7741330  
Email: info@ushamartin.it